

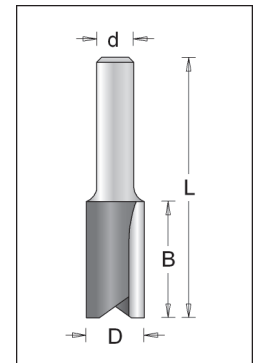

Nutfräser
fraise à rainurer

1/4" (110023)	8 mm (110028)	Code	D	B	L 1/4"/8 mm
23006		0006	3	8	41
23007	28007	0007	3	8	55
23008	28008	0008	4	11	51
23010	28010	0010	5	11	51
23012	28012	0012	6	19	51/57
23013		0013	6.5	19	51
23014	28014	0014	7	19	51
23016	28016	0016	8	19	51/57
23066	28066	0066	8	25	57/63
23017		0017	8.5	19	51
23018		0018	9	19	51
23020	28020	0020	10	19	51
23070	28070	0070	10	32	64
23021		0021	10.3	19	51
23022	28022	0022	11	19	51
23023		0023	11.3	19	51
23024	28024	0024	12	19	51
23074	28074	0074	12	32	64
23026	28026	0026	13	19	51
23076		0076	13	32	64
23028	28028	0028	14	19	51
23029	28029	0029	14.5	19	51
23030	28030	0030	15	19	51
23080	28080	0080	15	32	64
23032	28032	0032	16	19	51
23082	28082	0082	16	32	64
23086	28086	0086	18	32	64
23037		0037	18.2	19	51
23038	28038	0038	19	19	51
23040		0040	20	16	48
23090	28090	0090	20	19	51
23041		0041	20.2	19	51
23042		0042	21	19	51
23044	28044	0044	22	19	51
23050	28050	0050	25	19	51



- 1) Abdichtungsschlauchprofil m. HEBOR D83
pour joint silicone avec HEBOR D83
- 2) STELLUX-Stelleisten
pour crémaillères STELLUX
- 3) Stelleisten Kunststoff
pour crémaillères en matières plastique
- 4) Stelleisten
crémaillères
- 5) Vorhangschienen VS 57
pour rails de rideaux VS 57

- 6) Grass-Paumellen
pour paumelles Grass
- 7) "Praemeta"-Band 510,580,581,591
p. fiches "Praemeta" 510,580,581,591
- 8) Schloss-Stulpe
pour têtes de serrure
- 9) "Praemeta"-Band 541
pour fiches "Praemeta" 541
- 10) Grass-Band 712
pour fiches Grass 712

HM-Dübelbohrer HMS, 60°
mèche à goujon HMS, 60° en métal dur

1/4" (110023)	Code	D	L
23340	0340	4	56
23350	0350	5	56
23351	0351	5.1	56
23352	0352	5.2	56
23360	0360	6	56

01.05





Kantennutfräser 2-schneidig
fraise à rainurer 2-tranchants

ohne Welle/sans arbre	Code	D	B	d1
23102	0102	40	1.5	1/4"
23104	0104	40	1.8	1/4"
23133	0133	40	2.0	1/4"
23103	0103	40	2.5	1/4"
23106	0106	40	3.0	1/4"
23108	0108	40	4.0	1/4"
23110	0110	40	5.0	1/4"
23112	0112	40	6.0	1/4"

Verwendung mit Welle 23690 = 1/4" oder 28690 = 8 mm
emploi avec arbre 23690 = 1/4" ou 28690 = 8 mm

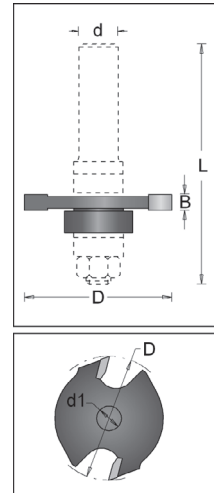

Kantennutfräser 3-schneidig
fraise à rainurer 3-tranchants

ohne Welle/sans arbre	Code	D	B	d1
23101	0101	47.6	2.0	5/16"
23105	0105	47.6	2.5	5/16"
23107	0107	47.6	3.0	5/16"
23109	0109	47.6	4.0	5/16"
23111	0111	47.6	5.0	5/16"
23113	0113	47.6	6.0	5/16"

Verwendung mit Welle 23689 = 1/4" oder 28689 = 8 mm
emploi avec arbre 23689 = 1/4" ou 28689 = 8 mm

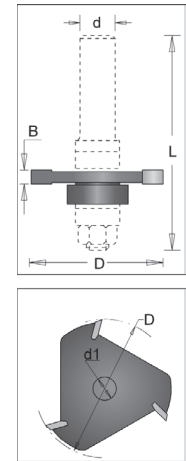

Wellen mit Distanzringen
arbres avec bagues

Nr. <i>No.</i>	Code <i>code</i>	Schaft <i>arbre</i>	Aufnahme <i>porte-fraise</i>	Total <i>totale</i>	Kugellager <i>roulement</i>
23689	0689	1/4"	5/16" - 8 mm	67	22x8
23690	0690	1/4"	1/4"	63.5	23691
28689	0689	8 mm	5/16" - 8 mm	70	22x8
28690	0690	8 mm	1/4"	58	23691
1109000048		1/2"	5/16" - 8 mm	76	ohne/ <i>sans</i>
1109000049		12 mm	5/16" - 8 mm	76	ohne/ <i>sans</i>

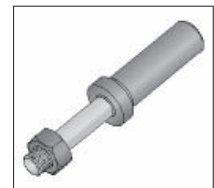

Distanzringe
bagues

EDV-Nr.	Code	Aussen/ <i>extérieur</i>	Innen/ <i>intérieur</i>	Stärke/ <i>largeur</i>
23700	0700	1/2"	1/4"	3
23701	0701	1/2"	1/4"	5
23702	0702	5/8"	1/4"	5

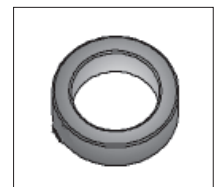



Kugellager
roulements à billes

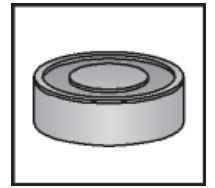

EDV-Nr.	Aussen/ <i>extérieur</i>	Innen/ <i>intérieur</i>	passend/ <i>approprié</i>
23653	1/2"	3/16"	23403-416,23563,23570,23654, 23672,23680,23915-23916,23918
23688	5/8"	3/16"	23563 (Neu)
23691	5/8"	1/4"	23600-23645
23692	3/4" - 19 mm	1/4"	23600-645, 23743
23703	1/4"	1/8"	23706-707
23695	3/8"	1/8"	23682,23695,23719-723, 23760-762,23905-910
23696	24 mm	1/4"	23600-23645
23697	16 mm	5 mm	23656
23698	3/8"	3/16"	23560,23563,23758-23764
23699	3/4" - 19 mm	3/16"	23562,23563
1105191020	22 mm	8 mm	23689

Umleimer
fraise pour affleurer les bordures



1/4" (110023)	Code	D	d
23180/15*	0180	40	8

Nutfräser für Abdichtungs-Schlauchprofil
fraise à rainurer pour joint silicon

1/4" (110023)	8 mm (110028)	Code	D	B	L
23007	28007	0007	3	8	55

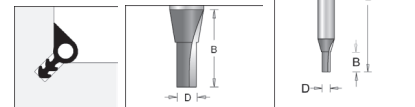

Schwalbenschwanzfräser für Abdichtungs-Schlauchprofil 25°
fraise à queue d'aigle pour joint silicon 25°

1/4" (110023)	8 mm (110028)	Code	D	B	L
23210		0210	5.1	8	60

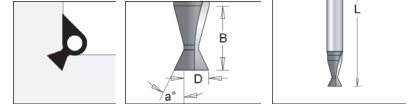

Ankerdichtungsfräser für Silicondichtung 38°
fraise "ancree" pour joint silicone 38°

1/4" (110023)	8 mm (110028)	Code	D/D1	B/B1	L
23211		0211	5.5/2	8/4	65

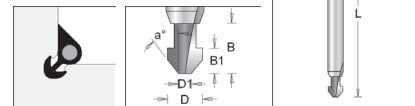

Ankerdichtungsfräser mit Hohlkehle für Silicondichtung
fraise "ancree" avec quart de ronde pour joint silicone

1/4" (110023)	8 mm (110028)	Code	D	B	L
23212		0212	10	13	63

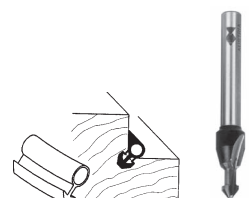

* auslaufend / *jusqu'à épauement du stock*
 01.05



Gratfräser

fraise à queue d'aigle

1/4" (110023)	8 mm (110028)	Code	a	D	B	L
23218	28218	0218	14°	12.7	12.7	44.5

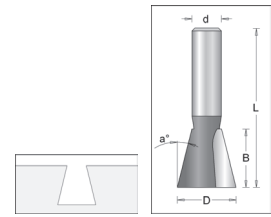

Zinkenfräser mit Vorritzer

fraise à queue d'aigle avec traceurs

1/4" (110023)	8 mm (110028)	Code	a	D/D1	B	L
23219	28219	0219	13°	14.3/12.7	13.5	55

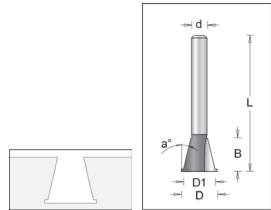

Scharniernutfräser

fraise à mortaiser

1/4" (110023)	8 mm (110028)	Code	D	B	L
23266	28266	0266	12.7	19	51

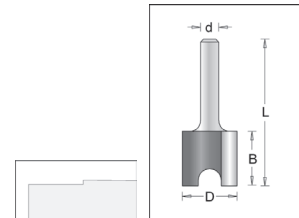

Abrundfräser (mit Kugellager 23653)

fraise à arrondir (avec roulement 23653)

1/4" (110023)	8 mm (110028)	Code	R	D	B	L
23403	28403	0403	3.2	19.1	9.5	50
23404	28404	0404	4.0	20.7	9.5	49.5
23406	28406	0406	4.8	22.2	12.7	52
23408	28408	0408	6.35	25.4	12.7	51.5
23410	28410	0410	7.9	28.6	13.5	53
23412	28412	0412	9.5	31.8	15.9	55.5
23416	28416	0416	12.7	38.1	19.1	58

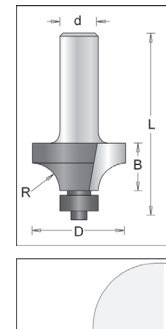

Fasefräser

fraise à chanfreiner

1/4" (110023)	8 mm (110028)	Code	a	D	B	L
23510		0510	10°	14.3	16	44.5
23515*		0515	15°	12.7	12.7	51
23522	28522	0522	23°	22.2	10	38.5
23530	28530	0530	30°	25.4	10	38.5
23545	28545	0545	45°	34.9	10	38.5

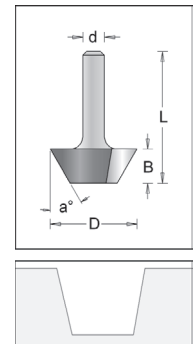

T - Nutfräser

fraise à rainurer "T"

1/4" (110023)	8 mm (110028)	Code	D	D1	B	L
23526	28526	0526	9.7	5.0	9.5	40

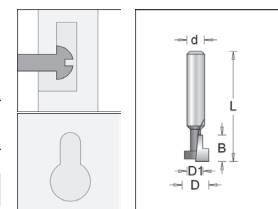



"V"-Nutfräser
fraise à rainurer en "V"

1/4" (110023)	8 mm (110028)	Code	a	D	B	L
23528	28528	0528	90°	12.7	12.7	41.5
23462	28462	0462	90°	14.3	12.7	41.5
23478	28478	0478	90°	25.4	19.1	48

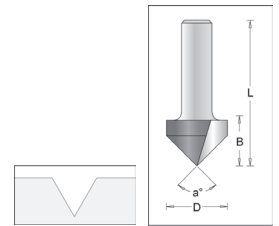

"V"-Nutfräser (mit Kugellager 1110030000)
fraise à rainurer en "V" (avec roulement 1110030000)

1/4" (110023)	8 mm (110028)	Code	a	D	B	L
23480		0480	45°	12.7	12.7	52

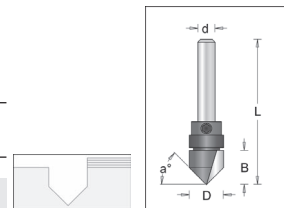

Ziernutfräser Vollhartmetall
fraise à rainurer tête en carbure monobloc

1/4" (110023)	8 mm (110028)	Code	a	D	B	L
23531	28531	0531	60°	14.0	22.2	57

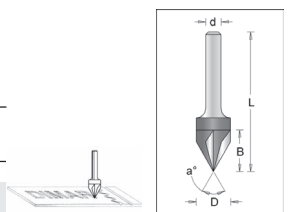

Falzfräser (mit 4 Kugellager)
fraise à battue (avec 4 roulements à billes)

1/4" (110023)	8 mm (110028)	Code	D	B	L
23563	28563	0563	35	12.7	52

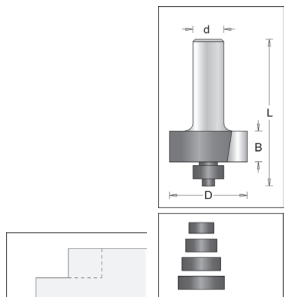

Dieser Satz ersetzt die Nr. 23562 / *Ce jeu remplace les* No. 23562
 Mit Kugellager / *avec roulements* 23653,23688,23698,23699

Falzfräser (mit Kugellager 23653)
fraise à battue (avec roulement 23653)

1/4" (110023)	8 mm (110028)	Code	D	B	L
23570	28570	0570	31.8	12.7	51.5

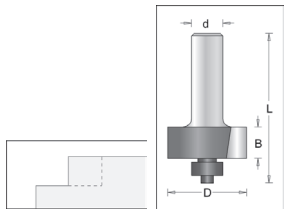

Bündig-Fasefräser
fraise d'affleurage et à chanfreiner

1/4" (110023)	8 mm (110028)	Code	a	D	B	L
23572	28572	0572	23°	12.7	12.7	41.3
23580	28580	0580	30°	12.7	12.7	41.3
23585		0585	35°	12.7	12.7	41.3
23595	28595	0595	45°	12.7	12.7	41.3

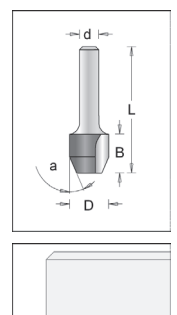

* auslaufend / *jusqu'à épauement du stock*



Bündigfräser 3-schneidig
fraise d'affleurage 3 tranchants

ohne Welle/sans arbre	Code	D	B
23600	0600	15.9	10

Mit Welle / *avec arbre* 23690 = 1/4"
 Mit Welle / *avec arbre* 28690 = 8 mm

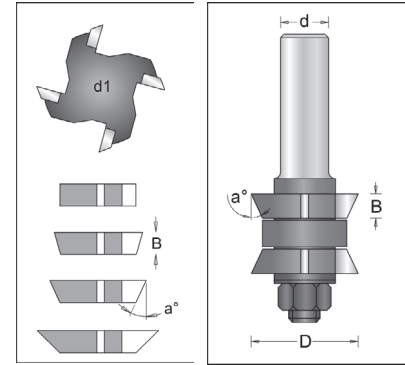

Fasefräser 3-schneidig
fraise à chanfreiner 3 tranchants

ohne Welle/sans arbre	Code	a	D	B
23622	0622	22°	23	10
23630	0630	30°	27	10
23645	0645	45°	35	10

Mit Welle / *avec arbre* 23690 = 1/4"
 Mit Welle / *avec arbre* 28690 = 8 mm



Bündigfräser
fraise d'affleurage

1/4" (110023)	8 mm (110028)	Code	D	B	L	Kugellager <i>roulement</i>
23650	28650	0650	12.7	6.3	53	23653
23654	28654	0654	12.7	25.4	67	23653
23656	28656	0656	16	16	56	23697
23664	28664	0664	19.1	16	61	23692

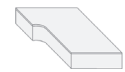
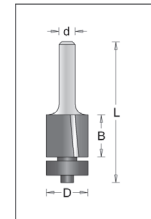

Bündigfräse-Garnitur mit 2 Hartmetall Wendeplatten
garniture d'affleurage avec 2 plaquettes réversible en métal dur

1/4" (110023)	8 mm (110028)	Code	D	B	L	Kugellager <i>roulement</i>
23660	28660	0660	12.7	9	57	23653
Wendeplatte/ <i>plaquette réversible</i>		23662	0662	9		

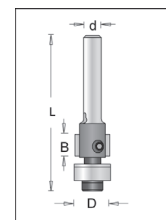

Fasefräser
fraise à chanfreiner

1/4" (110023)	8 mm (110028)	Code	a	D	B	L
23665	28665	0665	15°	19	10	49
23672	28672	0672	25°	19.1	6.35	53
23680	28680	0680	30°	19.1	6.35	53
23682	28682	0682	45°	31.8	12.7	51

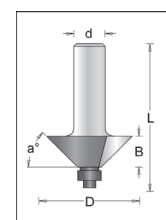



Kopierfräser
fraise à calibrer

1/4" (110023)	8 mm (110028)	Code	D	B	L
23706**		0706	6.35	12.7	52
23707**		0707	6.35	25.4	65
23758***		0758	9.5	25.4	69
	28758***	0758	9.5	25.4	72

** mit Kugellager / *avec roulement* 23703

*** mit Kugellager / *avec roulement* 23698

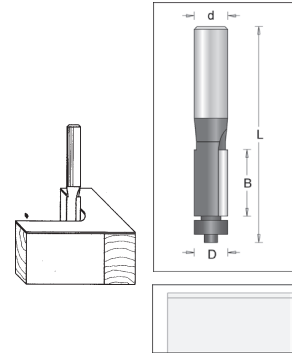

Kopierfräser
fraise à calibrer

1/4" (110023)	8 mm (110028)	Code	D	B	L
23708	28708	0708	6.35	19.1	63.5

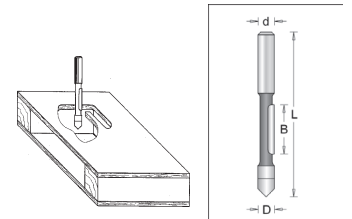

Hohlkehlfräser
fraise à gorge

1/4" (110023)	8 mm (110028)	Code	R	D	B	L
23712	28712	0712	4.8	9.5	6.35	38
23714	28714	0714	6.35	12.7	9.5	38
23716	28716	0716	7.9	15.9	11	40
23724	28724	0724	9.5	19.1	11	40
23728	28728	0728	12.7	25.4	17.5	46.5

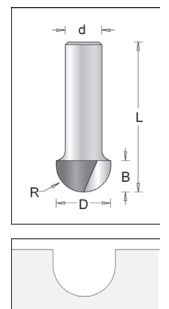

Halbhohlkehlfräser (mit Kugellager 23695)
fraise à demi-gorge (avec roulement 23695)

1/4" (110023)	8 mm (110028)	Code	R	D	B	L
23802	28802	0802	3.2	15.9	12.7	51
23806	28806	0806	4.8	19.1	14.3	51
23808	28808	0808	6.35	22.2	14.3	51
23810	28810	0810	7.9	25.4	14.3	51
23812	28812	0812	9.5	28.6	14.3	52
23816	28816	0816	12.7	34.9	16.7	55

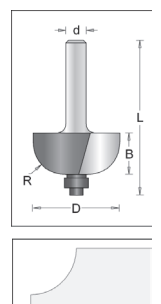

Viertelstabfräser
fraise à quart de rond

1/4" (110023)	8 mm (110028)	Code	R	D	B	L
23743		0743	3	19.1	10	51
23745		0745	5	22	12	55
23748		0748	8	28.6	14	58

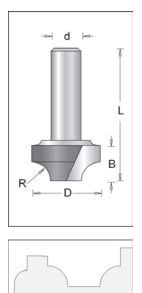



Viertelstabfräser (mit Kugellager 23695)

fraise à quart de rond (avec roulement 23695)

1/4" (110023)	8 mm (110028)	Code	R	D	B	L
23759	28759	0759	4.8	22.2	12.7	52
23760	28760	0760	6.35	25.4	12.7	51.5
23761	28761	0761	7.9	28.6	13.5	53
23762	28762	0762	9.5	31.8	15.9	55.5
23764	28764	0764	12.7	38.1	19.1	58

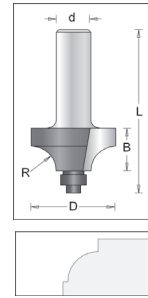

Profilfräser (mit Kugellager 23698)

fraise à profiler (avec roulement 23698)

1/4" (110023)	8 mm (110028)	Code	R	D	B	L
23905	28905	0905	4	25.4	15.9	54
23908	28908	0908	6.35	34.9	20	58

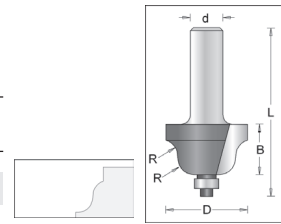

Profilfräser (mit Kugellager 23695)

fraise à doucine (avec roulement 23695)

1/4" (110023)	8 mm (110028)	Code	R	D	B	L
23909	28909	0909	4	25.4	16	54
23910	28910	0910	6.35	34.9	20	56.5

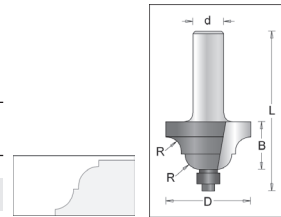

Profilfräser (mit Kugellager 23653)

fraise à doucine (avec roulement 23653)

1/4" (110023)	8 mm (110028)	Code	R	D	B	L
23915	28915	0915	4	28.6	12.7	52.5
23916	28916	0916	5.5	34.9	17	57

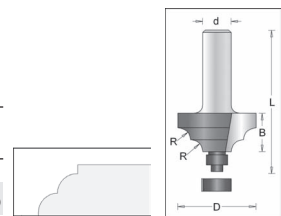

Profilfräser (mit Kugellager 23653)

fraise à doucine (avec roulement 23653)

1/4" (110023)	8 mm (110028)	Code	R	D	B	L
23918	28918	0918	4	34.9	13.5	54

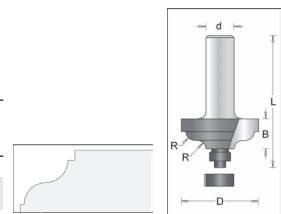

Profilfräser (mit Kugellager 23653)

fraise à doucine (avec roulement 23653)

1/4" (110023)	8 mm (110028)	Code	R/R1	D	B	L
23919	28919	0919	5/6	34.9	17.5	57

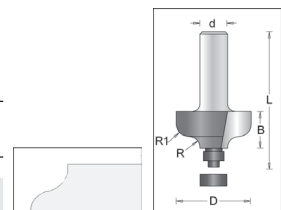



Halbrundfräser
fraise demi-ronde

1/4" (110023)	8 mm (110028)	Code	R	D	B	L
23932	28932	0932	2	13.5	12.7	41.3
23933	28933	0933	2.8	15.1	12.7	41.3
23934	28934	0934	3.6	16.7	19.1	47.6
23935	28935	0935	5.2	22.2	19.1	47.6

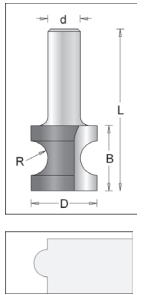

Profilfräser
fraise à doucine

1/4" (110023)	8 mm (110028)	Code	R	D	B	L
23940	28940	0940	2.5	9.8	9	49

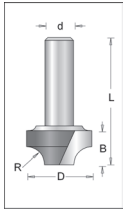
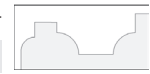

Profilfräser
fraise à doucine

1/4" (110023)	8 mm (110028)	Code	R	D	B	L
23951*		0951	2	12.7	9.5	51
23952*		0952	3.5	19.1	12.7	53

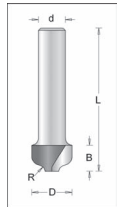

Profilfräser
fraise à doucine

1/4" (110023)	8 mm (110028)	Code	R1/R2	D	B	L
23981	28981	0981	3.7/4	19.1	12.7	54

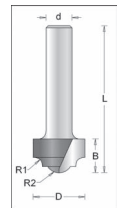

Reduzierhülse für Oberfräser
douille de réduction pour fraises pour défonceuses

1/4" (110023)	Code	D	d	L
23323	0323	8	1/4"	25



*auslaufend / *jusqu'à épuisement du stock*



Stufenfräser
fraise étagée

Roll-Tribloc

Nr./No.	Code	S	Qual.	D	d	l
22091	0091	1/4"	HSS	20.5	14	16/6
23091	0091	1/4"	HM	20.5	14	16/6
24391*		10	HSS	20.5	14	16/6
24691*		M10	HSS	20.5	14	16/6

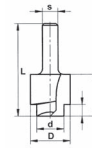

Treplane

Nr./No.	Code	S	Qual.	D	d	l
23092	092	1/4"	HM	18.3	13.3	15/5.5

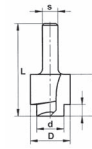

für Türverschluss BSV / 2000 / KW
pour fermeture de porte de sécurité BSV / 2000 / KW

Nr./No.	Code	S	Qual.	D	d	l
22094*	0094	1/4"	HSS	20.3	16	14/6
23094	0094	1/4"	HM	20.3	16	14/6

für Schliessblech GLUTZ 1160
pour gâche GLUTZ 1160

Nr./No.	Code	S	Qual.	D	d	l
22093*	0093	1/4"	HSS	28	17	16.3/2.2
23093*	0093	1/4"	HM	28	17	16.3/2.2
24393*		10	HSS	28	17	16.3/2.2
25393*		10	HM	28	17	16.3/2.2
24693*		M10	HSS	28	17	16.3/2.2
25693*		M10	HM	28	17	16.3/2.2
24193*		M12	HSS	28	17	16.3/2.2
25193*		M12	HM	28	17	16.3/2.2

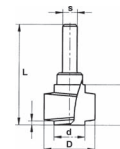

*auslaufend / *jusqu'à épaisseur du stock*

Nutfräser
fraise à rainurer



1/4" (110022)	Code	D	B	L
22012	0012	6	16	45
22062	0062	6	30	59
22014	0014	7	19	48
22016	0016	8	19	48
22066	0066	8	30	57
22018*	0018	9	19	48
22020	0020	10	19	48
22070	0070	10	30	60
22022*	0022	11	19	46
22024	0024	12	19	46
22074	0074	12	30	60
22026*	0026	13	22	49
22028	0028	14	16	43
22030	0030	15	16	43
22032	0032	16	16	43
22034*	0034	17	16	43
22037	0037	18.2	20.2	47
22038	0038	19	16	43
22040	0040	20	16	43
22041	0041	20.2	18.2	45
22042*	0042	21	20	48
22044	0044	22	16	43
22048	0048	24	16	49
22050	0050	25	17	44
22060	0060	30	17	44

Nutfräser (einschneidig)
fraise à rainurer (un tranchant)

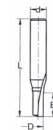

1/4" (110022)	Code	D	B	L
22104	0104	2	5	34
22106	0106	3	9	38
22108	0108	4	9	38
22110	0110	5	11	40
22111	0111	5.5	11	40

Gratfräser
fraise à queue d'aigle

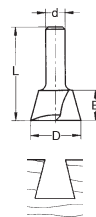

1/4" (110022)	Code	a	D	B	L
22209*	0209	15°	7.2	9.5	38
22210*	0210	15°	10	7	38
22212*	0212	15°	12	8	35
22214*	0214	15°	14	10	38
22218*	0218	15°	14.3	13.5	40
22220*	0220	9.25°	16	20	47

*auslaufend / *jusqu'à épauement du stock*

Scharniernutfräser
fraise à mortaiser les charnières

1/4" (110022)	Code	D	B	L
22262*	0262	9.5	11	45
22264*	0264	11.1	9.5	45
22266*	0266	12.7	10.3	43

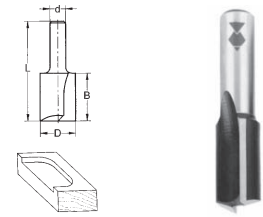

Abrundfräser (mit Anlaufzapfen)
fraise arrondir (avec appui)

1/4" (110022)	Code	R	D	B	L
22402	0402	2	8.8	9	44
22403	0403	3	10.8	10	45
22404	0404	4	12.8	11	46
22406	0406	5	14.8	12	47
22408	0408	6.3	17.4	13	48.4
22410	0410	8	20.8	15	50
22412	0412	9.5	23.8	17	51.5
22414	0414	12	28.8	18	53
22416	0416	12.7	30.2	19.7	54.7

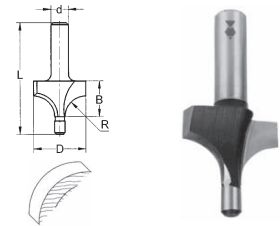

V-Nutfräser
fraise à rainurer en "V"

1/4" (110022)	Code	a	D	B	L
22462	0462	90°	14	14	41
22478	0478	90°	32	30	57

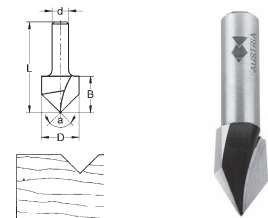

Fasefräser (mit Anlaufzapfen)
fraise à chanfreiner (avec appui)

1/4" (110022)	Code	a	D	B	L
22516	0516	45°	24	14	49

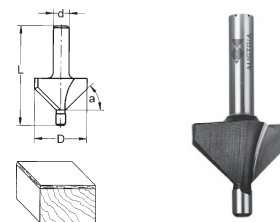

Falzfräser (mit Anlaufzapfen)
fraise à battue (avec appui)

1/4" (110022)	Code	D	B	L
22572	0572	17.5	11	46
22580	0580	23.8	12.7	47.7

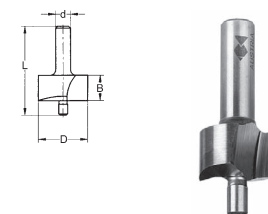

*auslaufend / *jusqu'à épauement du stock*

Hohlkehlfräser
fraise à gorge

1/4" (110022)	Code	R	D	B	L
22654	0654	1.6	3.2	8	37
22656	0656	2.4	4.8	11	40
22657	0657	3	6	11	40

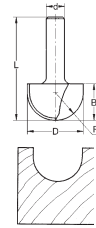

Hohlkehlfräser
fraise à gorge

1/4" (110022)	Code	R	D	B	L
22708	0708	3.2	6.4	6.5	33.5
22710	0710	4	8	7	34
22712	0712	4.8	9.6	7	34
22714*	0714	5.5	11	6.7	34
22716	0716	6.3	12.6	9	36
22718	0718	7.2	14.4	9.5	36.5
22720	0720	8	16	10	37
22722	0722	8.8	17.6	11	38
22724	0724	9.5	19	12.5	39.5

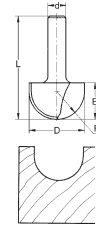

Viertelstabfräser (mit Anlaufzapfen)
fraise à quart de rond (avec appui)

1/4" (110022)	Code	R	D	B	L
22752*	0752	1.6	10	8	43
22754	0754	3.2	14.2	10	45
22758	0758	6.3	21.4	13	48
22762	0762	9.5	27.8	16	51

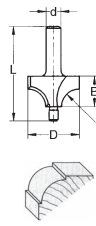

Halbhohlkehlfräser (mit Anlaufzapfen)
fraise à demi-gorge (avec appui)

1/4" (110022)	Code	R	D	B	L
22806	0806	4.8	12.7	14.4	47.7
22808	0808	6.4	17.6	12.7	47.7
22812	0812	9.5	23.8	19	54
22816	0816	12.7	30.2	19	54

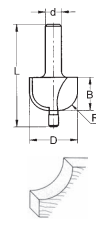

Profilfräser (mit Anlaufzapfen)
fraise à profiler (avec appui)

1/4" (110022)	Code	R	D	B	L
22905	0905	4	20.8	13	47.7
22908	0908	6.3	30	19	54

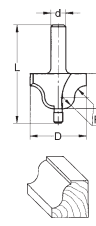

*auslaufend / *jusqu'à épauement du stock*

Kehlleistenfräser
fraise à doucine

1/4" (110022)	Code	R	D	B	L
22906	0906	4.8	20.6	16	43
22909	0909	7.2	30.2	23	50

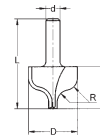

Bohrnutenfräser für Alu Schaft 8 mm
fraise à rainurer pour alu queue 8 mm

EDV-Nr. (8mm)	D	B	L
1100010030	3	12	60
1100010040	4	12	60
1100010050	5	12	60
1100010060	6	14	60
1100010080	8	14	80
lange Serie			
1100010051	5	40	100

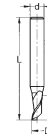

Bohrnutenfräser für Alu Schaft 8 mm
fraise à rainurer pour alu queue 8 mm

EDV-Nr. (8mm)	D	B	I	L
1100020051	5	18	35	80
1100020080	8	14	54	80
1100020081	8	14	80	120
EDV-Nr. (10mm)	D	B	I	L
1100020100	10	14	65	85
1100020101	10	14	95	120

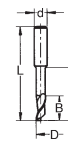

Nutfräser Hartmetall

fraise à rainurer en métal dur

EDV-Nr. (10 mm)	D	B	L
1100250412	6	12	65
1100250414	7	15	65
1100250416	8	20	65
1100250418*	9	20	65
1100250420	10	25	70
1100250422*	11	25	70
1100250424	12	25	70
1100250428	14	25	70
1100250430	15	25	70
1100250432	16	25	70
1100250482	16	40	97
1100250436	18	25	70
1100250437	18.2	25	70
1100250486	18	40	97
1100250440	20	25	70
1100250490	20	40	97
1100250444	22	25	70
1100250494	22	40	97
1100250448*	24	25	70
1100250450	25	25	70
1100250452*	26	25	70
1100250460	30	25	70

*auslaufend / *jusqu'à épuisement du stock*

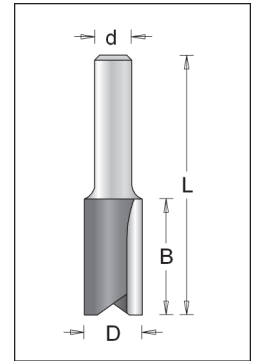

Nutfräser HSS

fraise à rainurer en ASR

EDV-Nr. (10 mm)	D	B	L
1100240416	8	30	70
1100240420	10	40	70
1100240424	12	40	75
1100240428	14	40	75
1100240432	16	40	75
1100240436	18	40	75
1100240440	20	40	75
1100240444	22	40	75
1100240450	25	40	75



Nutfräser
fraise à rainurer

EDV-Nr. (1/2")	EDV-Nr. (12 mm)	D	B	L
1108107010*		6	19	63
1108107022*	1109107022	8	19	63
1108107029*	1109107029*	10	19	63
1108107031*		10	25	69
1108107034	1109107034	10	32	76
1108107046*		12	25	66
1108107049	1109107049	12	32	73
1108107052		12	38	79
	1109107055	12	51	108
1108107061		14	25	66
1108107064*	1109107064*	14	32	73
1108107070*		16	25	66
1108107073	1109107073	16	32	73
1108107076		16	38	79
1108107085		18	32	73
1108107091*	1109107091*	19	25	66
1108107094*	1109107094*	19	32	73
1108107097*	1109107097	19	38	79
1108107103		20	25	66
1108107106		20	32	73
1108107112*		22	25	66
1108107115*		22	32	73
1108107121		25	25	66
1108107124*		25	32	73
1108107127*		25	38	79
1108107130		30	25	66
	1109107133*	30	32	73
1108107136*	1109107136*	35	25	66
1108107139*		35	32	73
1108107140*	1109107140	40	25	66
1108107145*		40	32	73

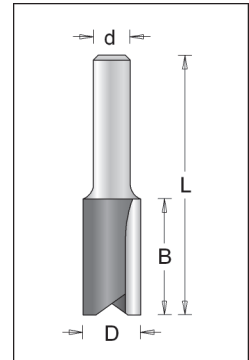

Fasefräser (mit Kugellager 23698)
fraise à chanfreiner (avec roulement 23698)

EDV-Nr. (1/2")	a	D	B	L
1108118001*	45°	31.8	12.7	60
1108118004	45°	50.8	19.1	69

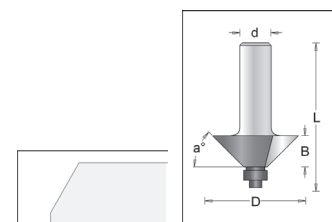

Kopierfräser
fraise à calibrer

EDV-Nr. (1/2")	EDV-Nr. (12 mm)	D	B	L
1108115007*	1109105007	12.7	30.1	88.9

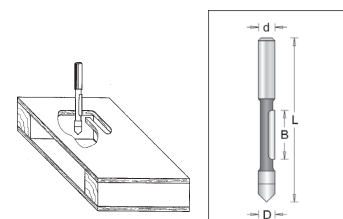

*auslaufend / *jusqu'à épauement du stock*



Gratfräser
fraise à queue d'aigle

EDV-Nr. (1/2")	EDV-Nr. (12 mm)	a	D	B	L
1108104004*	1109104004*	14°	12.7	12.7	60
1108104016*		14°	19.1	19.1	65

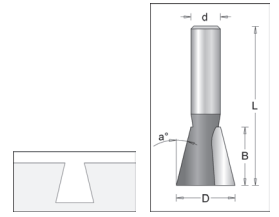

Ziernutfräser
fraise à rainurer en "V"

EDV-Nr. (1/2")	EDV-Nr. (12 mm)	a	D	B	L
1108105016*	1109105016*	90°	19.1	16	54
1108105022*		90°	31.8	25.4	63.5

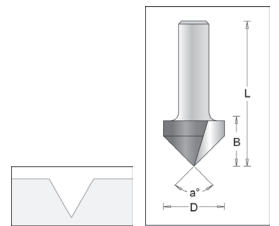

Hohlkehlfräser
fraise à gorge

EDV-Nr. (1/2")	EDV-Nr. (12 mm)	R	D	B	L
1108106009*	1109106009*	4.8	9.5	6.35	52
1108106018*	1109106018*	9.5	19.1	11	49.5

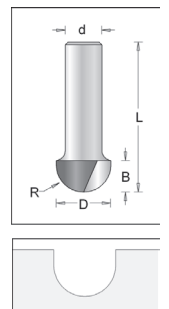

Halbhohlkehlfräser (mit Kugellager Nr. 23695)
fraise à demi-gorge (avec roulement 23695)

EDV-Nr. (1/2")	EDV-Nr. (12 mm)	R	D	B	L
1108112010*	1109112010	9.5	28.6	14.3	60.5
1108112013*	1109112013*	12.7	34.9	16.7	64

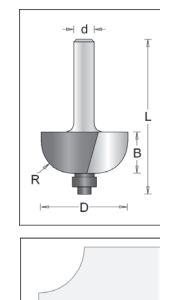

*auslaufend / *jusq'à épaissement du stock*



Nutfräser Hartmetall
fraise à rainurer en métal dur

EDV-Nr. (M10)	D	B	L
1100250512	6	14	55
1100250516	8	20	55
1100250520	10	22	55
1100250570	10	32	64
1100250524	12	22	55
1100250574	12	32	64
1100250528	14	25	55
1100250530	15	25	57
1100250532	16	25	57
1100250536	18	25	55
1100250540	20	25	55
1100250544	22	25	55
1100250594	22	45	77
1100250550	25	25	66



Nutfräser HSS
fraise à rainurer en ASR

EDV-Nr. (M10)	D	B	L
1100240520	10	20	52
1100240570	10	35	70
1100240524	12	20	52
1100240574	12	40	75
1100240528	14	22	52
1100240578	14	40	75
1100240530	15	25	52
1100240532	16	25	52
1100240582	16	45	77
1100240536	18	27	52
1100240540	20	27	52
1100240590	20	45	77
1100240544	22	27	52





Nutfräser Hartmetall
fraise à rainurer en métal dur

EDV-Nr. (M12x1.0)	D	B	L
1100250016	8	20	60
1100250020	10	25	60
1100250071	10	32	64
1100250023	11.3	25	60
1100250024	12	32	64
1100250075	12	45	77
1100250032	16	25	57
1100250036	18	25	55
1100250040	20	38	66
1100250044	22	25	60
1100250060	30	25	53



Nutfräser HSS
fraise à rainurer en ASR

EDV-Nr. (M12x1.0)	D	B	L
1100240016	8	20	60
1100240020	10	23	60
1100240070	10	40	72
1100240024	12	23	60
1100240074	12	35	67
1100240075	12	45	77
1100240028	14	23	60
1100240083	16	40	72
1100240036	18	25	60
1100240087	18	60	92
1100240060	30	25	60



Gratfräser HSS
fraise à queue d'aigle en ASR

EDV-Nr. (M12x1.0)	a	D	B	L
1100500014	15°	14	10	55
1100500016	15°	16	12	55
1100500018	15°	18	13	55

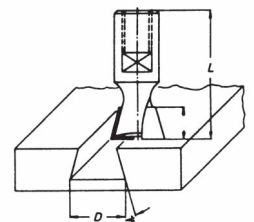



HM-Wendeplatten Nutfräser 2-Schneidig
fraise à rainurer avec 2 plaquettes en métal dur

EDV-Nr.	D	B	d	L
1113118014**	14	30	1/2"	86
1113119014**	14	30	12mm	86
1113138015	15	30	1/2"	86
1113139015	15	30	12mm	86
1113128016	16	30	1/2"	88
1113129016	16	30	12mm	88

Ersatzteile / pièces de rechange

1117930930	Platte / <i>plaquette</i> 9x30x1.5
1113543506	Torx M3.5x0.6
1113643506	**Torx SHT - M3.5x0.6
1111010015	Schlüssel / clé T15

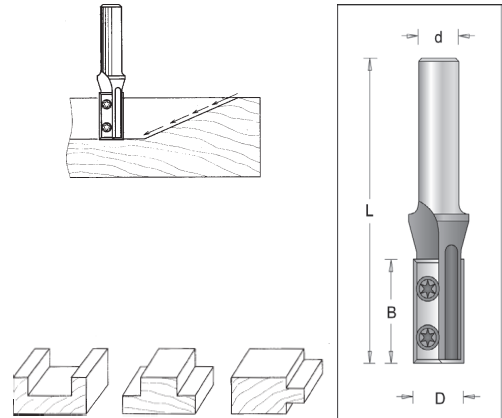

HM-Wendeplatten Nutfräser 2-Schneidig
fraise à rainurer avec 2 plaquettes en métal dur

EDV-Nr.	D	B	d	L
1113168018	18	30	1/2"	88
1113169018	18	30	12mm	88
1113178182	18.2	30	1/2"	88
1113179182	18.2	30	12mm	88
1113208020	20	30	1/2"	88
1113209020	20	30	12mm	88
1113248022	22	30	1/2"	88
1113249022	22	30	12mm	88
1113298025	25	30	1/2"	88
1113299025	25	30	12mm	88

Ersatzteile / pièces de rechange

1117231230	Platte / <i>plaquette</i> 12x30x1.5
1111484007	Torx M4x0.7
1111010015	Schlüssel / clé T15

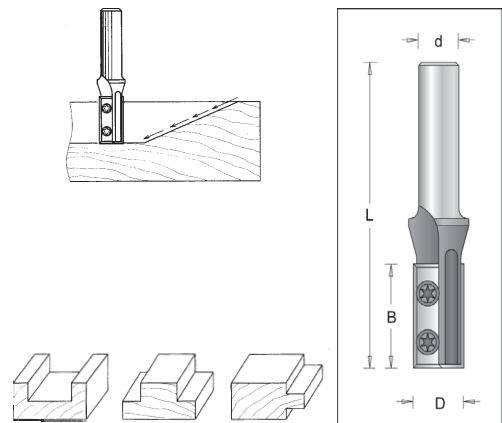

HM-Wendeplatten Nutfräser 2-Schneidig lang
fraise à rainurer avec 2 plaquettes en métal dur longue

EDV-Nr.	D	B	d	L
1113148016**	16	50	1/2"	107
1113149016**	16	50	12mm	107
1113188018	18	50	1/2"	107
1113189018	18	50	12mm	107
1113228020	20	50	1/2"	107
1113229020	20	50	12mm	107
1113268022	22	50	1/2"	107
1113269022	22	50	12mm	107

Ersatzteile / pièces de rechange

1117930930	**Platte / <i>plaquette</i> 9.x30x1.5
1113543506	**Torx M3.5x0.6
1117231230	Platte / <i>plaquette</i> 12x30x1.5
1111484007	Torx M4x0.7
1111010015	Schlüssel / clé T15

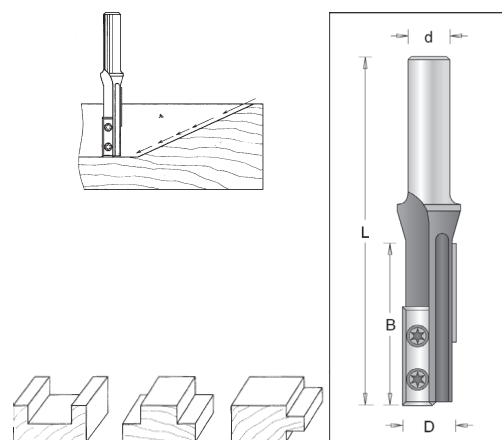



HM-Wendepplatten Nutfräser 1-Schneidig
fraise à rainurer avec 1 plaquette en métal dur

EDV-Nr.	D	B	d	L
1113508012	12	30	1/2"	77
1113509012	12	30	12mm	77
1113548014	14	30	1/2"	77
1113549014	14	30	12mm	77
1113558015	15	30	1/2"	77
1113559015	15	30	12mm	77

Ersatzteile / pièces de rechange

1117930930	Platte / <i>plaquette</i> 9x30x1.5
1113543506	Torx M3.5x0.6
1111010015	Schlüssel / <i>clé</i> T15

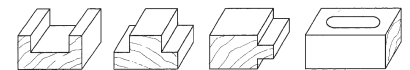
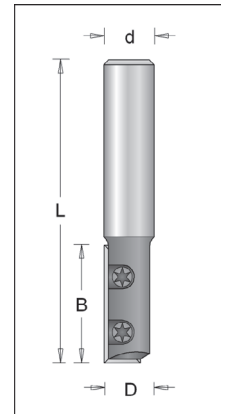
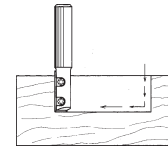

HM-Wendepplatten Nutfräser 1-Schneidig
fraise à rainurer avec 1 plaquette en métal dur

EDV-Nr.	D	B	d	L
1113588016	16	30	1/2"	88
1113589016	16	30	12mm	88
1113628018	18	30	1/2"	88
1113629018	18	30	12mm	88
1113668020	20	30	1/2"	88
1113669020	20	30	12mm	88
1113708022	22	30	1/2"	88
1113709022	22	30	12mm	88

Ersatzteile / pièces de rechange

1117231230	Platte / <i>plaquette</i> 12x30x1.5
1113543506	Torx M3.5x0.6
1111010015	Schlüssel / <i>clé</i> T15

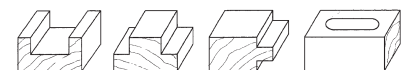
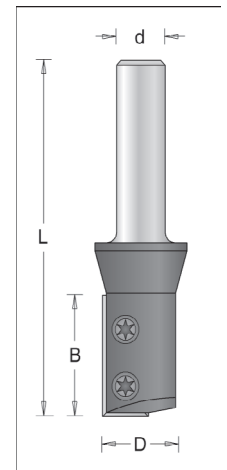

HM-Wendepplatten Nutfräser 1-Schneidig lang
fraise à rainurer avec 1 plaquette en métal dur longue

EDV-Nr.	D	B	d	L
1113608016	16	50	1/2"	107
1113609016	16	50	12mm	107
1113648018	18	50	1/2"	107
1113649018	18	50	12mm	107
1113688020	20	50	1/2"	107
1113689020	20	50	12mm	107
1113728022	22	50	1/2"	107
1113729022	22	50	12mm	107

Ersatzteile / pièces de rechange

1117251250	Platte / <i>plaquette</i> 12x50x1.5
1113543506	Torx M3.5x0.6
1111010015	Schlüssel / <i>clé</i> T15

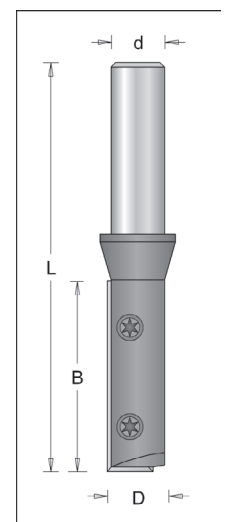
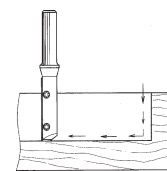



HM-Wendeplatten Nutfräser 1-Schneidig, stirnschneidend
fraise à rainurer avec 1 plaquette en métal dur, coupe au bout

EDV-Nr.	D	B	d	L
1113788025	25	30	1/2"	86
1113789025	25	30	12mm	86

Ersatzteile / *pièces de rechange*

1117231230	Platte / <i>plaquette</i> 12x30x1.5
1111484007	Torx M4x0.7
1117517512	Platte / <i>plaquette</i> 12x7.5x1.5
1111484017	Torx SHT M4x0.7
1111010015	Schlüssel / <i>clé</i> T15

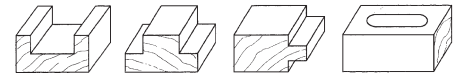
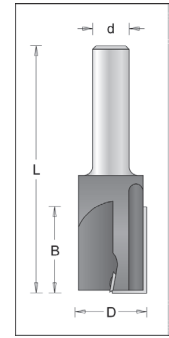

HM- Wendeplatten Nut-, Falz- u. Bündigfräser 2-Schneidig
fraise à rainurer, à battue et d'affleurage avec 2 plaquettes en métal dur

EDV-Nr.	D	B	d	L
1113014018	18	12	1/4"	44
1113018018	18	12	1/2"	50
1113015018	18	12	8mm	44
1113019018	18	12	12mm	50
1113024020	20	12	1/4"	44
1113028020	20	12	1/2"	50
1113025020	20	12	8mm	44
1113029020	20	12	12mm	50
1113034022	22	12	1/4"	44
1113038022	22	12	1/2"	50
1113035022	22	12	8mm	44
1113039022	22	12	12mm	50

Ersatzteile / *pièces de rechange*

1111211212	Platte / <i>plaquette</i> 12x12x1.5
1111484007	Torx M4x0.7
1111010015	Schlüssel / <i>clé</i> T15

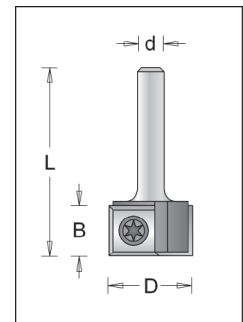

HM-Wendeplatten Nut-, Falz- u. Bündigfräser 2-Schneidig
fraise à rainurer, à battue et d'affleurage avec 2 plaquettes en métal dur

EDV-Nr.	D	B	d	L
1113064018	18	20	1/4"	52
1113068018	18	20	1/2"	60
1113065018	18	20	8mm	52
1113069018	18	20	12mm	60
1113074020	20	20	1/4"	52
1113078020	20	20	1/2"	60
1113075020	20	20	8mm	52
1113079020	20	20	12mm	60
1113084022	22	20	1/4"	52
1113088022	22	20	1/2"	60
1113085022	22	20	8mm	52
1113089022	22	20	12mm	60

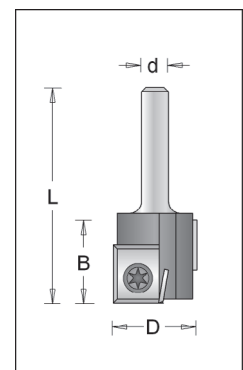
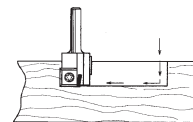
Ersatzteile siehe oben / *pièces de rechange voir ci-dessus*



HM-Wendepplatten-Multifasenfräser 1-Schneidig mit Kugellager-Anlaufring
multifraise avec 1 plaquette en métal dur et roulement à billes

EDV-Nr.	D	a1	a2	d	L
1112204014*	14	15°	30°	1/4"	55
1112205014*	14	15°	30°	8mm	59
1112214014*	14	23°	45°	1/4"	55
1112215014*	14	23°	45°	8mm	59

Ersatzteile / *pièces de rechange*

1117517512	Platte / <i>plaquette</i> 12x7.5x1.5
1111484017	Torx SHT M4x0.7
1111484007	Torx M4x0.7
1110090714	Kugellager / <i>roulement</i> 7x14x5
1111010015	Schlüssel / <i>clé</i> T15

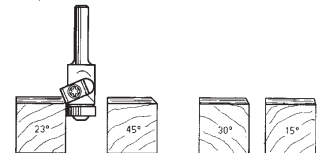
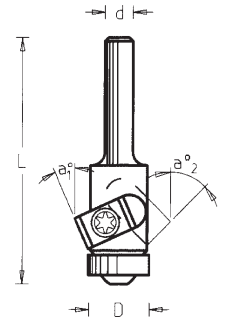

HM-Wendepplatten-Multifasenfräser 1-Schneidig mit Kugellager-Anlaufring
multifraise avec 1 plaquette en métal dur et roulement à billes

EDV-Nr.	D	a1 a3	a2 a4	d	L
1114208014*	14	15° 30°	23° 45°	1/2"	72
1114209014*	14	15° 30°	23° 45°	12mm	72

Ersatzteile / *pièces de rechange*

1117517512	Platte / <i>plaquette</i> 12x7.5x1.5
1111484017	Torx SHT M4x0.7
1111484007	Torx M4x0.7
1110090714	Kugellager / <i>roulement</i> 7x14x5
1111010015	Schlüssel / <i>clé</i> T15

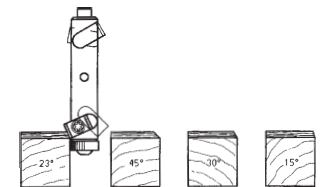
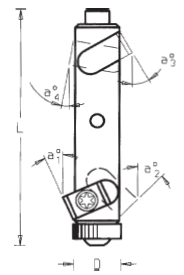

HM-Wendepplatten Bündigfräser 2-Schneidig mit Kugellager-Anlaufring
fraise d'affleurage avec 2 plaquettes en métal dur et roulement à billes

EDV-Nr.	D	B	d	L
1119404019**	19	12	1/4"	52
1119405019**	19	12	8mm	54
1119444019	19	30	1/4"	70
1119448019	19	30	1/2"	78
1119445019	19	30	8mm	72
1119449019	19	30	12mm	78

Ersatzteile / *pièces de rechange*

1111211212	**Platte / <i>plaquette</i> 12x12x1.5
1111231230	Platte / <i>plaquette</i> 12x30x1.5
1110120619	Kugellager / <i>roulement</i> 6x19x6
1111484007	Torx M4x0.7
1111010015	Schlüssel / <i>clé</i> T15

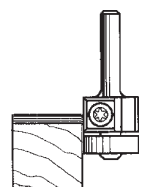
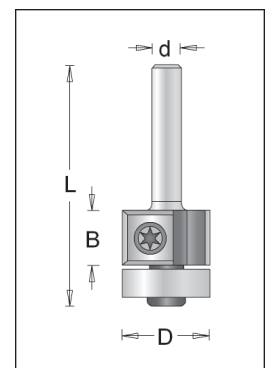

HM-Wendeplatten Fasenfräser 2-Schneidig mit Kugellager-Anlaufring
fraise à chanfreiner avec 2 plaquettes en métal dur et roulement à billes

EDV-Nr.	D	B	a	d	L
1111524020	20	12	15°	1/4"	55
1111525020	20	12	15°	8mm	55
1112524024	24	12	25°	1/4"	55
1112525024	24	12	25°	8mm	55
1113024026	26	12	30°	1/4"	54
1113025026	26	12	30°	8mm	54

Ersatzteile / *pièces de rechange*

1111211212	Platte / <i>plaquette</i> 12x12x1.5
1111484007	Torx M4x0.7
1110050000	Kugellager / <i>roulement</i> 1/4x5/8x3/16"
1111010015	Schlüssel / <i>clé</i> T15

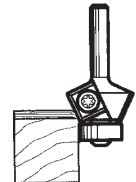
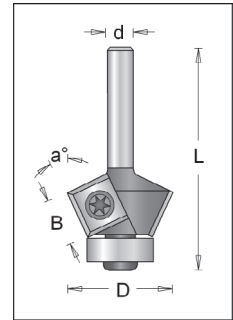
HM-Wendeplatten V-Nutenfräser 2-Schneidig mit Kugellager-Anlaufring
fraise à rainurer en V avec 2 plaquettes en métal dur et roulement à billes

EDV-Nr.	D	B	a	d	L
1114524027	27	12	45°	1/4"	57
1114525027	27	12	45°	8mm	57

Ersatzteile / *pièces de rechange*

1111211212	Platte / <i>plaquette</i> 12x12x1.5
1111484007	Torx M4x0.7
1110030000	Kugellager / <i>roulement</i> 1/4x1/2x3/16"
1119370000	Führung / <i>guide Delrin</i> 1/4"x27x1/4"
1111010015	Schlüssel / <i>clé</i> T15

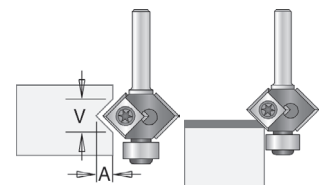
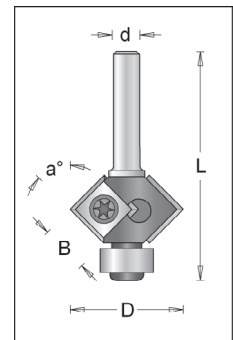
Kugellager für V-Nutenfräser / *roulement pour fraises à rainurer en V*

		A	V
1110030000	1/4x1/2x3/16"	7	14
1110050000	1/4x5/8x3/16"	5	10
1110140000	1/4x19x1/4"	3.2	6.4

Anwendung der 45°
Delrin Führung
*Utilisation du guide
Delrin à 45°*

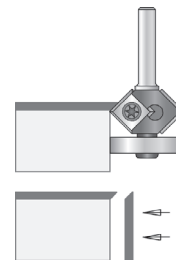



Spannzangenfutter (komplett)
mandrin pour pinces (complet)

EDV-Nr. (M12x1)	Nr. / No.	Spannzange / <i>pince</i> (mm)
1100120950	89172.9,5	9.5
1100121000	89172.10	10
1100121270	89172.12,7	12.7

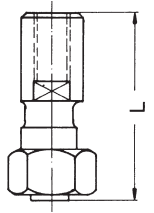

Spannzangeneinsatz
pince de serrage

EDV-Nr. (M12x1)	Nr. / No.	für Schaft / <i>pour tige</i> (mm)
1100130600**	89100.6	6
1100130950***	89100.9,5	9.5
1100131200***	89100.12	12

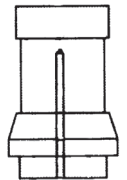

** M 10 + M 12
 *** M 12

Verlängerungsstück
rallonges

EDV-Nr.	Nr. / No.	d ₁ /d ₂	AL
1100141800	89772.18	M 12x1	18
1100142500	89772.25	M 12x1	25
1100143500	89772.35	M 12x1	35
1100144000	89772.40	M 12x1	40

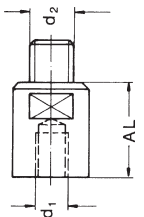

Hartmetall-Wendeplatten
plaquette en carbur monobloc

EDV-Nr.	Nr. / No.	B	H	S	VPE
1100150760	L 7.6	7.6	12	1.5	10
1100150960	L 9.6	9.6	12	1.5	10
1100151200	L 12	12	12	1.5	10
1100151500	L 15	15	12	1.5	10
1100152000	L 20	20	12	1.5	10
1100153000	L 30	30	12	1.5	10
1100154000	L 40	40	12	1.5	10
1100155000	L 50	50	12	1.5	10
1100156000	L 60	60	12	1.5	10
1100158000	L 80	80	13	2.2	10
1100161000	L 100	100	13	2.2	10

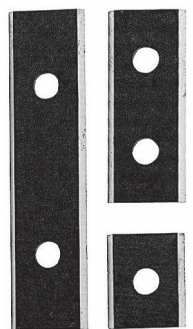

Vorschneider / *Ebaucheur*

1100161410	L 141	14	14	1.2	10
1100161420	L 142	14	14	2	10

Wendplatte / *Plaquette*

1100181420	NF 1420	14	14	2	10
1100181820	NF 1820	18	18	1.95	10



Hartmetall-Wendemesser

lame réversible en carbur monobloc



EDV-Nr.	Nr. / No.	B	H	S	VPE
1100177500	KF 75	75	5.5	1.1	10
1100178000	KF 80 ELU	80.5	5.9	1.2	10
1100178200	KF 82	82	5.5	1.1	10

Verstellbarer Holzbohrer "203 BM" (Hartmetall)

mèche à bois réglable "203 BM" (métal dur)

EDV-Nr.	Nr. / No.	D	L (mm)	S
1100303060	203 BM	30-60	140	10x16

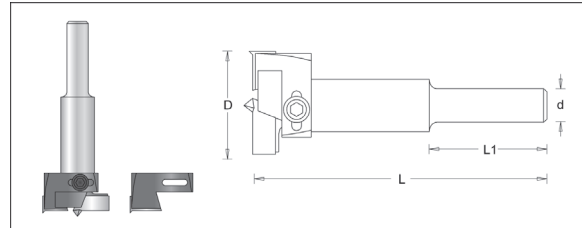

RYGO-Holzversenker 90° "202 CS" (Hartmetall)

fraise à bois 90° "202 CS" (métal dur)

EDV-Nr. 1100300202

RYGO der neue Holzversenker mit grosser Verstellbarkeit!

Mit RYGO bohren und senken Sie in einem Arbeitsgang. Der Arbeitsbereich dieses Werkzeuges liegt bei 3-7 mm.

Der Holzsenker RYGO wird einfach auf den gewünschten Bohrer geklemmt und schon ist das sehr praktische Werkzeug betriebsbereit! Inbusschrauben nicht zu stark anziehen! Ohne Bohrer!

La nouvelle fraise à bois RYGO, avec une grande réglage!

Avec RYGO vous percez et chanfreinez en une seule fois.

La fraise doit être serrée sur la mèche choisie.

Ne serrer pas trop les vis.

Livrée sans mèches.

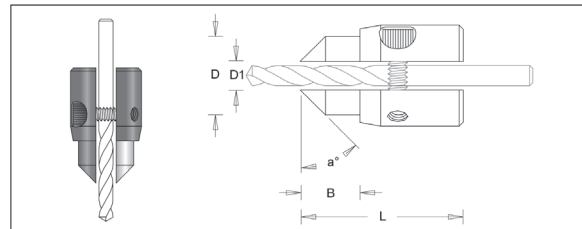

HM-Fräser Lamello "700"

fraise métal dur Lamello "700"

EDV-Nr.	D	B	d	Z
1100310700	100	4	22	6

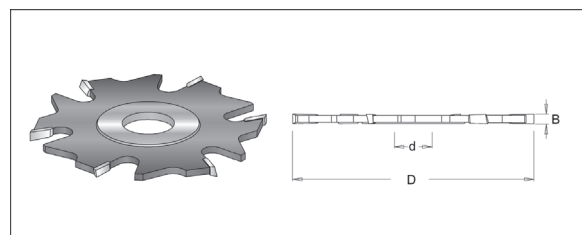

HM-Wendemesser und Lamello-Nuter "610" komplett

porte-outils pour Lamello, métal dur "610" complet

EDV-Nr.	D	B	d	Z
1100320610	100	4	22	6

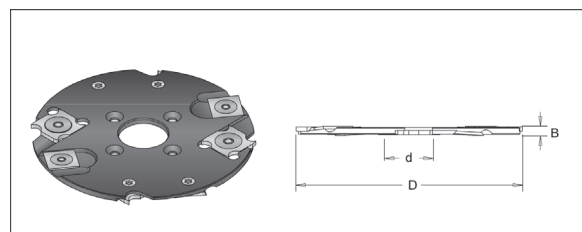

Wendeplatten (je 4 Stk.)

plaque en carbure monobloc (4 pcs. de chaque)

1100181820	NF 1820	18x18x1.95	HM-Räumer
1100161410	L 141	14x14x1.2	HM-Vorschneider



Harzgallenfräser "971 N"
fraise pour réparation "971 N"

EDV-Nr.	D	B	d	Z
1129710000	100	8	22	4

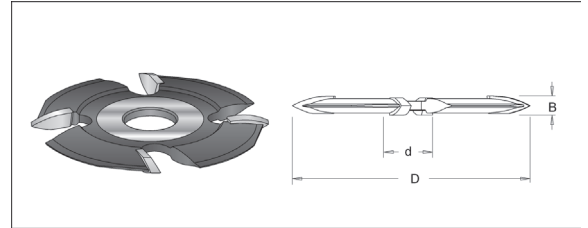

Dimar Multicut (Profilfräsersatz)
Dimar Multicut (jeu de fraises à profiler)

EDV-Nr. 1100330500
 Komplet mit 5 Fräsern Typ A-E
complet avec 5 fraises Typ A-E

Typ	Nr.	B mm	Z	d mm
A	116	10	2	30
B	127	15	2	30
C	140	6	2	30
D	140	15	2	30
E	140	4	2	30

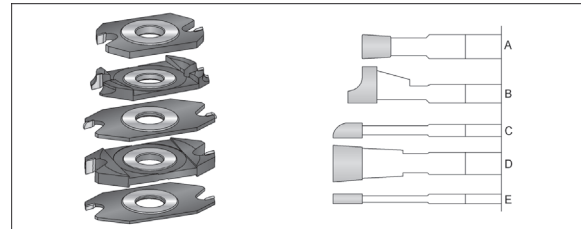

Profilbeispiele

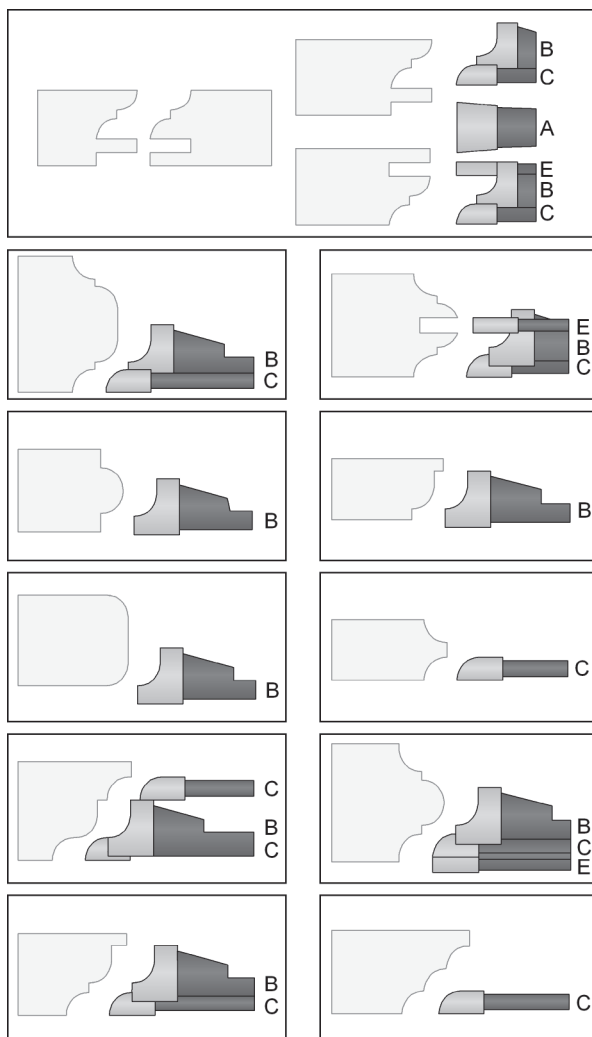

Exemples des profils

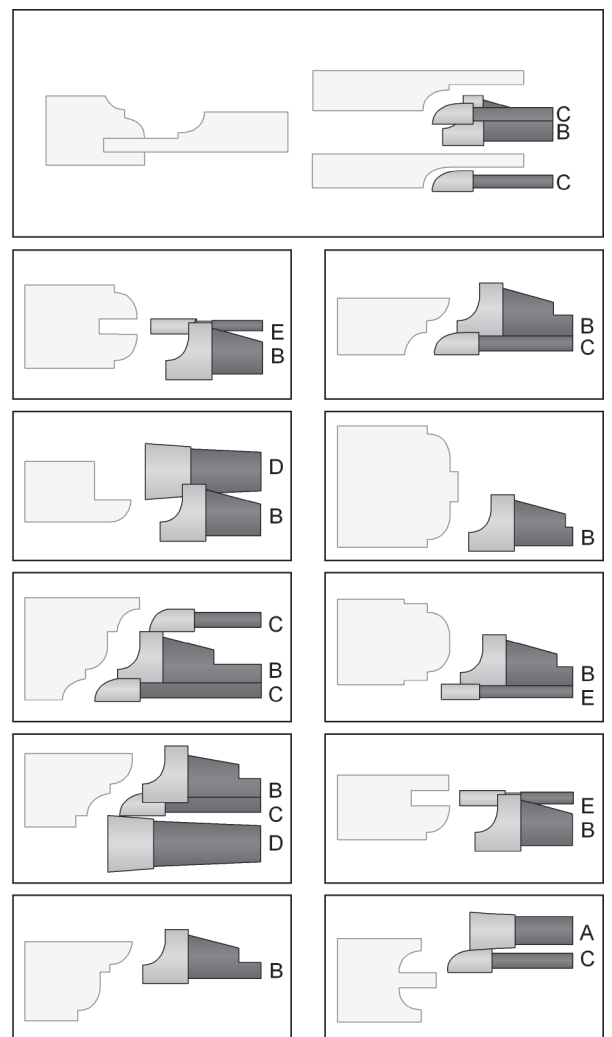



HM Kunstbohrer "203 B"

(mit Zentrierspitze, 2 Vorschneider, zyl. Schaft \varnothing 10x30mm, TL 90mm)

*mèche à façonner "203 B" avec plaquette en md
 (pointe de centr., 2 araseurs. Queue cyl. \varnothing 10x30mm. L. t. 90mm)*

EDV-Nr.	\varnothing mm	EDV-Nr.	\varnothing mm
1120430080	8	1120430300	30
1120430100	10	1120430310	31
1120430110	11	1120430320	32
1120430120	12	1120430330	33
1120430130	13	1120430340	34
1120430140	14	1120430350	35
1120430150	15	1120430360	36
1120430160	16	1120430370	37
1120430170	17	1120430380	38
1120430180	18	1120430390	39
1120430190	19	1120430400	40
1120430200	20	1120430420	42
1120430210	21	1120430440	44
1120430220	22	1120430450	45
1120430230	23	1120430460	46
1120430240	24	1120430480	48
1120430250	25	1120430500	50
1120430260	26	1120430550	55
1120430270	27	1120430580	58
1120430280	28	1120430600	60
1120430290	29		

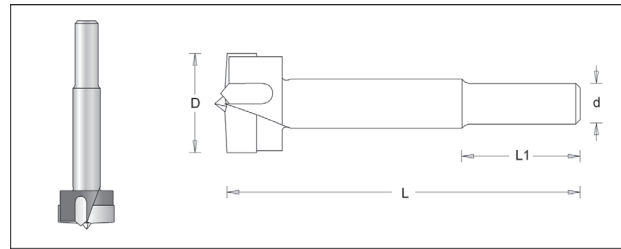

Oberfräsersatz HM 12-teilig

jeu de fraises en métal dur 12 pcs.

EDV-Nr. (1/4") 10850002	Inhalt/ <i>contenu</i>	D	a	R
1100350001	Nutfräser WPW	6		
1100350002	Nutfräser WPW	12		
1100350003	Nutfräser WPW	16		
1100350004	Zinkfräser WPW		14°	
1100350005	Abrundfräser WPW			6.35
1100350006	Abrundfräser WPW			9.5
1100350007	Bündigfräser WPW	12.7		
1100350008	Ziernutfräser WPW	12.7	90°	
1100350009	Fasefräser WPW	32	45°	
1100350010	Hohlkehlfäser WPW	12.7		6.3
1100350011	Hohlkehlfäser WPW	22		6.3
1100350012	Profilfräser WPW	25		4.0
1100350001	fraise à rainurer WPW	6		
1100350002	fraise à rainurer WPW	12		
1100350003	fraise à rainurer WPW	16		
1100350004	fraise à queue d'aigle WPW		14°	
1100350005	fraise à arrondir WPW			6.35
1100350006	fraise à arrondir WPW			9.5
1100350007	fraise d'affleurage WPW	12.7		
1100350008	fraise à rainurer WPW	12.7	90°	
1100350009	fraise à chanfreiner WPW	32	45°	
1100350010	fraise à gorge WPW	12.7		6.3
1100350011	fraise à gorge WPW	22		6.3
1100350012	fraise à profiler WPW	25		4.0

